



CX.200



- ✓ Modular brake
- ✓ Long life span
- ✓ Constant and precise torque control
- ✓ Minimum maintenance
- ✓ High heat dissipation
- ✓ Compact size
- ✓ Respect for the environment and operator's health

Since more than 40 years the Combiflex pneumatic brake has been representing the reference brake for the converting industry, today it's the best seller brake in the world.

The experience gained during years, thousands of applications, the constant research into materials and the studies carried out on brakes performance, have allowed us to increase our know how and to continually improve our product.

All our Combiflex brakes are equipped with asbestos free pads to guarantee respect for the working environment and the operator's health; moreover, they are equipped with a single fan and a turbine disc that convey the air flow in the crucial zone of the brake increasing the life span, the heat dissipation and reducing the maintenance.

Combiflex is a modular brake, it means that we can provide it with a number of calipers required by the application; moreover, the distributors of each caliper can always be accessed in order to select the most suitable number of calipers for the regulation.

Combiflex brake that guarantees long life span of the pads, constant and precise torque control, high heat dissipation and compact size.

TECHNICAL DRAWING

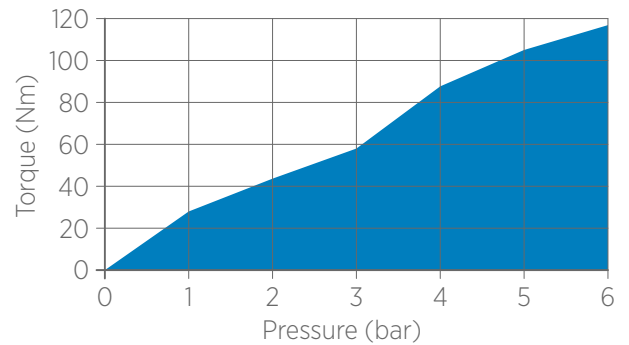
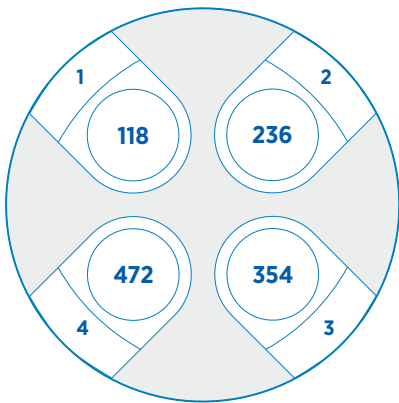
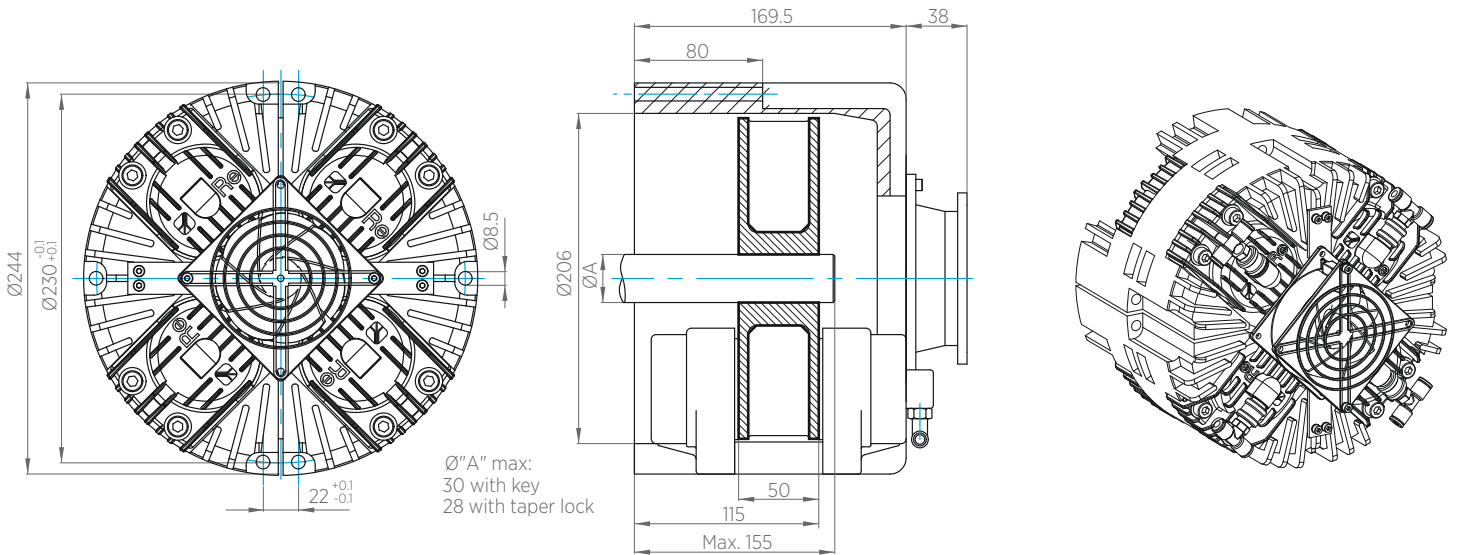

N. of calipers
 Torque in Nm relating n. of calipers

TECHNICAL CHARACTERISTICS

Torque max 1 caliper	118 Nm
Torque min 1 caliper	1,2 Nm
Pressure min / max	0,3/6 bar
Max disc rpm	3000 rpm
Total weight	18 kg
Disc inertia	0,02 Kgm ²
Heat dissipation without fan	0,7 kW
Heat dissipation with 24V/110V/220V fan	1,5 kW

*Data are subject to technical change without notice

** Torque values relate to dynamic slipping



Re S.p.A.
via Firenze 3
20060 Bussero (MI) Italy

T +39 02 9524301
F +39 02 95038986
E info@re-spa.com

Assistenza tecnica
Technical support
T +39 02 952430.300
E support@re-spa.com

Assistenza commerciale
Sales support
T +39 02 952430.200
E sales@re-spa.com